

# Operating Instructions for the Air Flow Sensors and Monitors of Series F3.xEx and NLSW45-3Ex (Gg)



The person installing the devices as well as the system operator are obligated to ensure the satisfaction of the mandatory national ex-legislation. Electrostatic charges on plastic parts and wires must be avoided. The devices must be protected from any damage. The wire connecting the flow sensor must be attached to stationary surfaces and must be protected from any harm. Stray radiation must be avoided.

Our products satisfy the requirements specified in the European directives WEEE 2012/19/EU and RoHS 2011/65/EU.



# Table of Contents

<b>1. Preamble.....</b>	<b>1</b>
1.1 Safety Instructions .....	1
<b>2. General Information on Explosion Protection .....</b>	<b>1</b>
2.1 Electrical Specifications for Ex-i .....	2
2.2 Intrinsically Safe Parameters.....	2
2.3 Sensor Properties for Series F3.xEx .....	3
2.4 Type Code.....	3
2.5 Dimensions of the Air Flow Sensors F3.xEx .....	3
2.5.1 F3Ex.....	3
2.5.2 F3.1Ex.....	3
2.5.3 F3.2Ex.....	4
2.5.4 F3.3Ex.....	4
2.6 Temperature Class.....	4
2.7 General Requirements .....	4
2.7.1 Intended Use.....	4
2.7.2 General Safety Instructions .....	4
<b>3. Installation and Start-Up .....</b>	<b>5</b>
3.1 Installation Conditions of the Air Flow Sensors F3.xEx .....	6
3.2 Installation .....	6
<b>4. Maintenance and Service .....</b>	<b>7</b>
4.1 Definitions .....	7
<b>5. Troubleshooting .....</b>	<b>8</b>
<b>6. Disposal .....</b>	<b>8</b>
<b>7. Labelling of the Air Flow Sensors F3.xEx .....</b>	<b>8</b>
<b>8. Technical Data of the Air Flow Monitors NLSW45-3Ex .....</b>	<b>9</b>
<b>9. Installation of the Air Flow Monitors NLSW45-3Ex .....</b>	<b>9</b>
9.1 Start-Up and Switch-Point Adjustment .....	10



# 1. Preamble

## 1.1 Safety Instructions

Please read the entire operating instructions to ensure the full operational capability of the devices and your own safety **before** starting their installation. If questions arise you may contact the manufacturer SEIKOM-Electronic GmbH & Co.KG directly. The directions, contained in these operating instructions, must be followed.

The products were assessed according to the following standards:

- a) IEC 60079-0:2017 Ed. 7 “*Explosive atmospheres – Part 0: Equipment – General requirements*”
- b) IEC 60079-11:2011 Ed. 6 + Corr. 2012 / EN 60079-11:2012 “*Explosive atmospheres – Part 11: Equipment protection by intrinsic safety “i”*”
- c) TRGS 727:2016 “*Vermeidung von Zündgefahren infolge elektrostatischer Aufladung*”

## 2. General Information on Explosion Protection

The intrinsically safe air flow sensor measures flow velocities in the range of 0.1...20 m/s via the calorimetric principle. According to the operating principle either the degree of cooling (cooling method) or the required amount of heat, necessary to maintain the heating sensor elements’ temperature constant (constant temperature method), is determined to indicate flow.

The air flow sensors of the series F3.xEx are built for commercial use and shall only be used according to the technical documentation provided by SEIKOM-Electronic GmbH & Co.KG and specifications on their labels. The air flow sensors shall only be operated with certified products via an intrinsically safe electrical circuit, which is fed by Zener-barriers. These barriers satisfy valid standards and provisions.

The general provisions on the construction of facilities in areas exposed to explosion hazards (e.g. EN 60079-11) need to be considered.

More important details can be found in the alongside delivered EC type examination certificate.

The requirements regarding simple electrical utilities applicable within areas exposed to explosion hazards due to gases in zone 1 according to EN 60079-11 are satisfied.

In accordance with its label, the air flow sensor can be used as specified below:

- In zone 2 (Gas-Ex, EPL Gc) in ex-groups IIA, IIB and IIC.

The qualification concerning the surface temperature is T4. The equipment does not present an ignition source for any gases, vapours and fogs with an ignition temperature above 135 °C.

The permissible ambient temperature range for the air flow sensor is  $0\text{ °C} \leq T_a \leq 60\text{ °C}$ . The permissible ambient temperature range for the NLSW45-3Ex is  $-20\text{ °C} \leq T_a \leq 50\text{ °C}$ . The permissible media temperature (air flow sensor) is  $0\text{ °C} \leq T \leq 60\text{ °C}$ .

Self-heating is generally negligible, in case of failure the threshold values of temperature class T4 may be reached.



## 2.1 Electrical Specifications for Ex-i

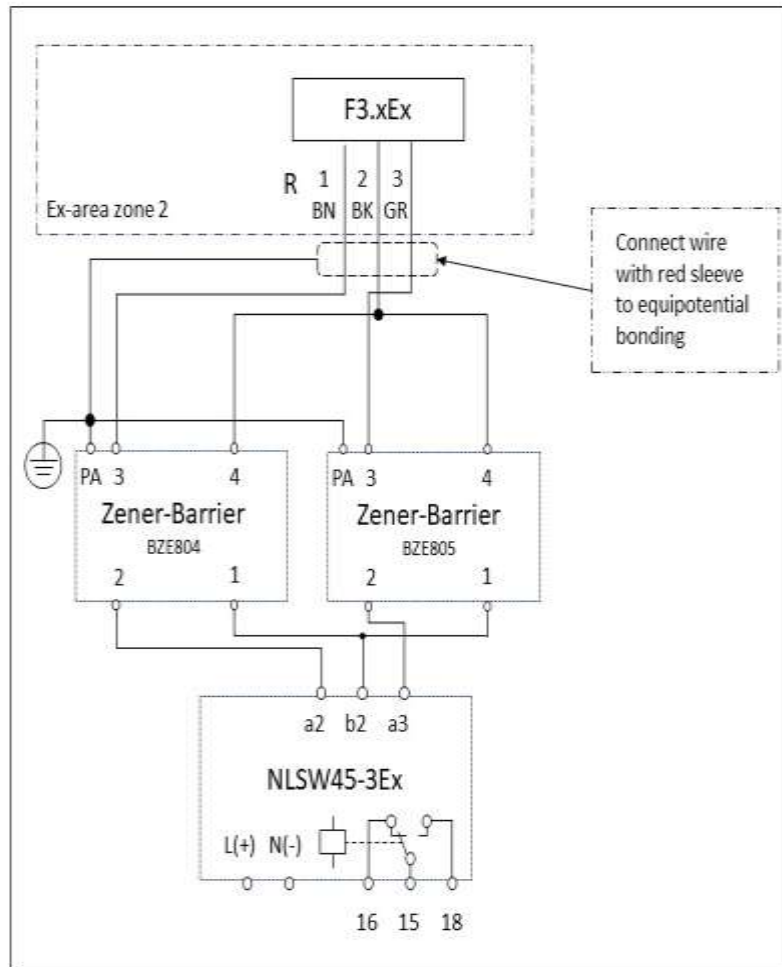



When installing, please note that the Z-barriers BZE804 and 805 have different values! If the barriers are swapped, the air flow monitor NLSW45-3Ex will not function properly!

## 2.2 Intrinsically Safe Parameters

Type	Value
$U_i$	25 VDC
$I_i$	80 mA
$P_i$	0,35 W @ 40 °C
	0,24 W @ 110 °C
$C_i$	negligible
$L_i$	negligible



## 2.3 Sensor Properties for Series F3.xEx

Type	F3Ex	F3.1Ex	F3.2Ex	F3.3Ex
Article-No	50276/ex	50276/130/Ex	50276/150/Ex	50276/300/Ex
Approx. immersion depth	50 mm	130 mm	165 mm	300 mm
Permissible media temperature	0 °C ... +60 °C (depends on the flow monitor)			
Permissible ambient temperature	0 °C ... +60 °C			
Temperature gradient	30 K/min			
Connection	PG 7			
Sensor tube material	CuZn39Pb2, nickel plated			
Compression strength	10 bar			
Electrical connection	2,5 m / 3 x 0.75 mm <sup>2</sup>			
Protection class	IP67			
Evaluation unit	NLSW45-3Ex, NLSW75AEx			
Wire colors	Black numbered			
Tested according to DIN EN 61010-1:2011-07 by TÜV-Nord				
 				

## 2.4 Type Code

There is only one kind of flow sensor F3, the different types vary only by their length. Please review the table shown above.

## 2.5 Dimensions of the Air Flow Sensors F3.xEx

### 2.5.1 F3Ex

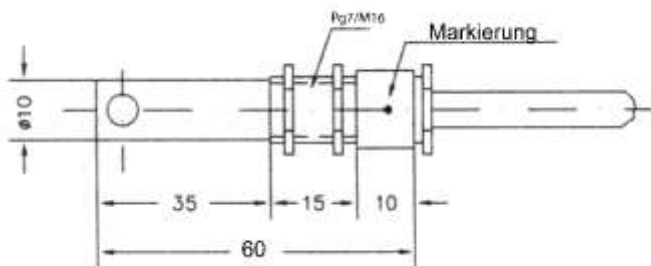

### 2.5.2 F3.1Ex

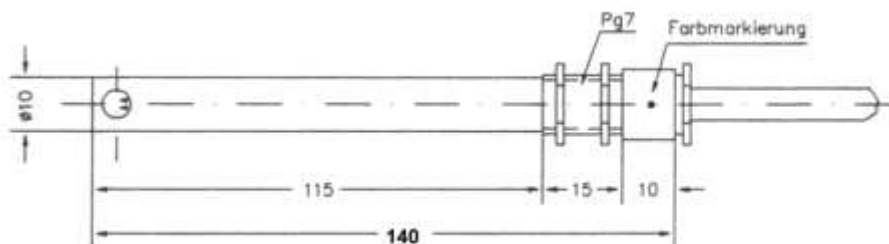



### 2.5.3 F3.2Ex

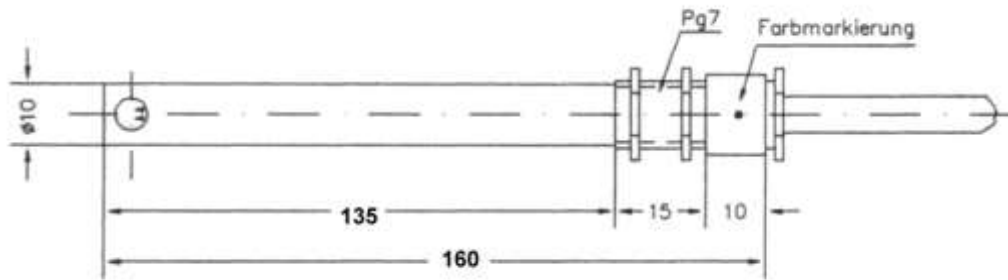

### 2.5.4 F3.3Ex

Design like F3.2Ex, but immersion depth 300mm. The drawing will be available in the near future.

## 2.6 Temperature Class

The sensors are suitable for use with temperature class T4.

## 2.7 General Requirements

### 2.7.1 Intended Use

- Safe use can only be ensured if the devices are used according to the specifications of the operating instructions provided in this document. Moreover, the legal and safety requirements specific to the individual use must be satisfied. This is also applicable to the use of additional equipment such as accessories.
- Incorrect use of the product or deviation from the directions contained by this instruction result in a cancellation of our liability. Furthermore, any warranty on products or spare parts will be cancelled.
- The products are no safety features in the scope of their dedicated use.
- Only original parts from the manufacturer can be used.

### 2.7.2 General Safety Instructions

The sensor corresponds to the best available technology and is reliable in operation. If installed or operated incorrectly, for instance due to installation or operation by unqualified personnel, a residual risk may arise from the sensor.

Any person conducting the installation, start-up, maintenance or repair of the air flow sensors and monitors must have read and understood the operating instructions and especially the safety instructions.

- Consider general engineering rules and the dedicated use when choosing a product.
- All electrical and mechanical equipment must be suitable for their intended use.
- Pay attention to the information provided in this manual as well as the permissible operating conditions printed on the label/type plate of the respective product.
- Ensure that only products with the required ignition protection type, depending on the zone, are installed!
- The products are only approved for their designated and appropriate use in ordinary industrial atmosphere. Immersion in liquids is impermissible.
- Ensure that no falling objects may hit the product. In connection with rust (corrosion), light metal and kinetic energy an exothermal, ignitable reaction can result.
- The operator has to ensure the lightning protection according to local regulations.
- Follow general engineering rules when choosing and operating products.



- i) The person performing the installation of the air flow sensors and their connection to the flow monitors is responsible for their correct function and must ensure that they are eligible for their intended use.
- j) The intrinsically safe connection, including the air flow sensors, must be carried out via approved flow monitors, which, if necessary, must be installed with suitable Zener-barriers or switching amplifiers.

### 3. Installation and Start-Up

Depending on the IP protection class time intervals for cleaning of the equipment (accumulation of dust) must be set. Additional important facts:

- a) The product can be installed in zone 2 (Cat. 3G, EPL Gc) or in zone 1 (Cat. 2G, EPL Gb) in intrinsically safe electrical circuits by professionals equally competent to qualified personnel according to TRBS 1203.
- b) The information provided on the label must be followed bindingly during installation.
- c) The products can only be operated in ordinary industrial atmosphere. The manufacturer must be contacted if the atmosphere contains aggressive components. In case of adverse ambient conditions, the sensors need to be protected accordingly.
- d) Usage of the devices is only permissible when they are fully mounted and connected in an intact condition. Damages would enable a zone entrainment which must therefore be considered by the operator. Usage of devices with damaged casing is not permitted.
- e) The in this operating instructions defined permissible ambient conditions must be met, the products must be protected from adverse ambient conditions.
- f) Thermal radiation of other components and products must be considered.
- g) The air flow sensors must be protected from impermissible inflow of liquids and/or pollution.
- h) Tight or stuck parts, e. g. due to frost or corrosion, cannot be loosened with force if exposed to an explosive atmosphere. Icing must therefore be avoided.
- i) The air flow sensors can only be exposed to minor vibrations, see IEC 34-14.
- j) To ensure the dissipation of electrostatic charges, national regulations must be considered.
- k) Especially capacities that build up in an isolated manner must be avoided.
- l) The flow sensor housing should be connected to the potential equalization electrostatically, a threshold value of  $1M\Omega$  is permissible.
- m) Only Zener-barriers and switching amplifiers with Ex-area approved output circuits can be used. In Europe the use within zone 1 requires an EC type examination for the relevant equipment, issued by a for explosion protection appointed authority.
- n) The power  $P_0$  of all supply units combined must be lower or equal to the power  $P_i$  of the air flow sensors.
- o) The supply voltage of the supply units must be lower or equal to the voltage  $U_i$  of the air flow sensors.
- p) The current  $I_0$  of all supply units combined must be lower or equal to the current  $I_i$  of the air flow sensors.
- q) For the installation of an intrinsically safe electrical circuit, a block diagram (system description) is necessary, which must be provided by the builder or operator.
- r) If a Zener-barrier is used, a potential equalisation between the grounding connection and the flow sensor casing alongside the intrinsically safe electrical circuit must be ensured
- s) The certificates including the therein defined special conditions must be considered.
- t) Tight or stuck parts, e. g. due to frost or corrosion, cannot be loosened with force if exposed to an explosive atmosphere.
- u) The flow sensors cannot be used in facilities with cathodic corrosion protection. Although special precautions might enable the use of the flow sensors in this special case, the manufacturer must be contacted in any scenario. Parasitic currents cannot be discharged via the construction.
- v) Within the area exposed to an explosion hazard the installation must comply with local regulations.



The following conditions must be met:

- Installation and maintenance may only be executed in atmospheres without any explosion hazard and in compliance with the applicable national regulations depending on the location of operation.
- Additional precautions must be made if hydrogen sulphide, ethylene oxide or carbon monoxide may be or are present. These substances require only very low energy to ignite!
- In case these substances and a substance of explosion group IIC and a presumably explosive atmosphere are present only non-arcing tools can be used!

### 3.1 Installation Conditions of the Air Flow Sensors F3.xEx

Please consider the following points while mounting the air flow sensors to avoid any malfunction:

- The tip of the sensor should be placed in the centre of the tube. The gaseous medium must fully flow through the drilled hole located within the tip section of the sensor.
- The mark on the base of the sensor may be used to verify whether the opening of the drilled hole points in the direction of the flow.
- In case of vertical tubing the direction of flow should be upwards.
- An inlet zone of  $5xD$ , before the sensor, and an outlet zone of  $3xD$ , after the sensor should be maintained ( $D$ =inner diameter of the pipe).
- The air flow sensor must be connected with the air flow monitor according to the block diagram. Any alteration of the connections leads to malfunction and may result in defects.
- The shield must be connected to the potential equalisation.
- An extension of the sensor wiring (shielded) is only permitted if the wiring is used in non-explosive atmosphere. Yet, a total length of 30 m at a minimum cross section of  $1,5 \text{ mm}^2$  cannot be exceeded.

During operation the following points concerning the wiring must be considered for the connection cable:

- In case of flexible mounting of the cable the applicable temperature range is  $-5 \text{ }^\circ\text{C}$  up to  $+80 \text{ }^\circ\text{C}$  with a minimum bend radius of  $10x$  wire diameter.
- In case of stationary mounting the applicable temperature range is  $-40 \text{ }^\circ\text{C}$  up to  $+80 \text{ }^\circ\text{C}$  with a minimum bend radius of  $10x$  wire diameter.

The wiring is not eligible for outdoor use or burying in the ground. Please contact the manufacturer if the present operating conditions deviate from the specifications.

### 3.2 Installation

The sensor can be mounted via the PG7 connected to the sensor housing. Furthermore, mounting can be supported by the alongside delivered PG7-nuts. During mounting the mark may be used to ensure the correct orientation of the hole within the tip of the sensor, so that the medium can fully flow through it. During start-up of the device with media temperatures below  $0 \text{ }^\circ\text{C}$  and strong air flow, the start-up time may increase to 60 s.

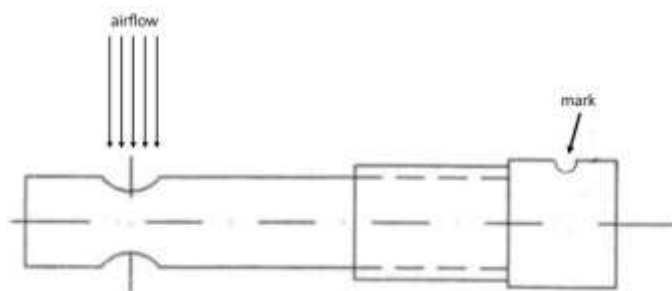





## 4. Maintenance and Service

### 4.1 Definitions

Definitions according to IEC 60079-17:

**Maintenance and Repair:** A combination of activities, carried out to maintain an object in a certain condition or to regain this condition, which satisfies the requirements of the relevant specifications and ensures the ability to perform the demanded functions.

**Inspection:** An activity, involving the thorough investigation of an object, with the aim of obtaining a reliable conclusion regarding the condition of the object, which is conducted without removal of the object, or if necessary with partial removal, complemented by actions such as measurements.

**Visual Inspection:** A visual inspection is an examination during which visible faults may be recognized (e. g. missing screws) without application of any tools or gaining further access.

**Close Inspection:** An inspection that exceeds the visual inspection, during which faults may be recognized (e. g. loose screw) that require further access or the utilization of tools. Neither opening a housing nor switching to zero potential is usually required for a close inspection.

**Detailed Inspection:** An inspection that exceeds the close inspection, enabling the detection of faults (e. g. loose connections) that can only be recognized if a housing is opened and/or, if necessary, tools and testing equipment are utilized.

- a) Maintenance activities can only be performed by qualified personnel.
- b) Accessories used within areas exposed to explosion hazards have to satisfy the requirements of the European directives and national legislation.
- c) Maintenance activities involving the removal of sensors can only be performed in areas without any explosion hazards.
- d) Only original parts, dedicated for the use within areas exposed to explosion hazards, can be used for the replacement of components.
- e) Products within the area exposed to an explosion hazard must be serviced and cleaned regularly. The intervals must be determined by the operator according to the environmental stress on site.

Activity	Monthly visual inspection	Close inspection every 6 months	Detailed inspection every 12 months
Visual check of the sensors regarding damage, removal of accumulated dust	●		
Inspection regarding intactness and function			●
Inspection of the entire facility	Responsibility of the operator		

Polluted air flow sensors shall only be cleaned in lukewarm soapy water. Before reinstallation the sensors should be air-dried completely. **Never** use hard or sharp objects (e. g. screwdriver, steel brush) for cleaning.



## 5. Troubleshooting

Products used in areas exposed to explosion hazards cannot be altered or modified. Repair of the product can only be performed by qualified and authorised personnel which has received specialised education in this field.

Problem	Cause	Solution
NLSW45-3Ex does not work	No or wrong supply voltage	Check supply voltage and connection
NLSW45-3Ex cannot identify flow	Sensor not installed correctly or the measured range does not correspond to the technical data	Check installation conditions and installation
NLSW45-3Ex shows changed response behaviour	Sensor is polluted	Clean the sensor with lukewarm soapy water
NLSW45-3Ex switches in case of fast temperature increase	The temperature gradient exceeds the technical data	Re-adjust switch-point

## 6. Disposal

The disposal of the packaging materials and used parts must be in accordance with the national regulations relevant in the location of operation of the product.

## 7. Labelling of the Air Flow Sensors F3.xEx



Every air flow sensor of the series F3.xEx carries a readable label which specifies the required explosion protection class as specified below. The label cannot be removed. Generally, a readable identification of the required explosion protection class in field use must be attached before the first use of the product.

SEIKOM-Electronic GmbH & Co.KG Fortunastr. 20 D-42489 Wülfrath	
Type: F3.*Ex	
[Serial number]	CE [Year of construction]
TFR: 18 ATEX 0003	
II 3G Ex ic IIC T4 Gc	
0 °C ≤ Ta ≤ 60 °C	

A sensor, that was once used in a not intrinsically safe electric circuit, **cannot** be used in intrinsically safe electric circuits subsequently.



## 8. Technical Data of the Air Flow Monitors NLSW45-3Ex

Type	NLSW45-3Ex	NLSW45-3Ex	NLSW45-3Ex
Article-No	77029/DC/Ex	63377/Ex; 63377/115/Ex	77029/AC/Ex
Operating voltage	24 VDC	230 VAC; 115V AC, 60 Hz	24 VAC
Voltage tolerance	± 5 %		
Signal display, voltage	Green LED		
Max. power consumption	3 VA/W	4,5 VA/W	3 VA/W
Permissible ambient temperature	-20..+50 °C		
Overvoltage category	II		
Signal output flow	1 changeover contact		
Current and contact rating	250 V AC, 8 A, 2 kVA		
Switch function in case of flow	Relay contact changes		
Signal display flow	Yellow LED		
Start-up suppression	Adjustable, 5 s...60 s		
Display of start-up suppression	None		
Applicable range of media temperature	0 °C...+60 °C		
Switch-point	Adjustable via potentiometer		
Measurable range	0,1 m/s...20 m/s		
<b>Flow sensors</b>	<b>F3Ex, F3.1Ex, F3.2Ex, F3.3Ex</b>		
Z-Barrier	2 pcs. included in delivery		
Electrical connection	10 clips, 2,5 mm <sup>2</sup>		
Casing	Standard housing N45		
Casing dimensions	L=120 mm; W=45 mm; H=73 mm		
Protection class casing	IP40		
Protection class clips	IP20		
Mark of conformity	Tested according to DIN EN 61010-1:2011-07 by TÜV-Nord  		

## 9. Installation of the Air Flow Monitors NLSW45-3Ex

The air flow monitors of the series NLSW45-3Ex must be mounted, together with the safety barriers, outside of the area exposed to an explosion hazard. The protection class IP40 of the housing must be considered.

Connection and start-up must be conducted by qualified personnel. The mandatory competence of qualified personnel includes knowledge of the types of ignition protection as well as provisions and regulations concerning equipment in ex-zones! Verify whether the classification (according to these instructions and the labelling of the devices) is sufficient for the dedicated use.

The housing enables mounting on a profile rail NS35/7,5 according to DIN EN 50022-35. If the profile rail is exposed to larger vibrations, it has to be mounted in a vibration-reducing manner. Please follow the provisions of DIN EN 60034-14 (IEC34-14).



Furthermore, the following points must be considered:

- a) For the installation of an intrinsically safe electrical circuit a block diagram (system description) is required, which must be supplied by the builder or operator
- b) The installation can only be conducted in a cleared status
- c) The start-up can only be performed after the mounting and electrical connection have been finished
- d) The permissible ambient conditions specified in this operating instruction cannot be exceeded

**ATTENTION: It is not permitted to connect the connection “N” of the supply voltage with b2 (strand no. 2) of the sensor wire when using a 24 AC and DC air flow monitor of the series NLSW45-3Ex!**

## 9.1 Start-Up and Switch-Point Adjustment

The relation between air flow velocity and resistance change is non-linear. In the lower section (small flow) the change of resistance is large. The change of resistance becomes smaller with constant increase of the flow velocity in the upper section. This characteristic should be considered when adjusting the switch-point. Moreover, the following requirements must be taken into account:

**Small changes of flow in the high section of flow velocity:** The switch-point must be chosen close to the usual value of the flow, because the changes of the measured value are very small with changing flow. Since the temperature compensation lags behind the real change of temperature, such a kind of switch-point adjustment is only possible in use cases with slow temperature change.

**Small changes of flow in the small section of flow velocity:** The switch-point can be selected with a certain distance to the usual value of the flow, since changes in the measured value are large for changing flow. Temperature changes are not influencing the switching behavior.

**Large changes of flow:** In this case a yes/no response is desired (e. g. to verify that a fan is working or not). Therefore a large interval may be selected, so that neither temperature changes nor turbulences may impact the switching behavior.

For the start-up the following approach is recommended:

1. Install the air flow sensor and monitor according to the instructions.
2. Adjust the potentiometer „airflow“ on the air flow monitor to minimal sensitivity (left).
3. Adjust the potentiometer „time“ to the desired time of start-up suppression (about 5-60 seconds, turn right to the maximum equals 60 seconds).
4. Supply voltage; the green LED lights up and the potential-free switcher operates; the device is ready to operate within five seconds.
5. The yellow LED lights up until the start-up suppression expires and extinguishes subsequently.
6. Activate the flow generation.
7. Turn the potentiometer „airflow“ slowly towards maximum until the yellow LED lights up and the potential-free switcher operates; in order to obtain stable switching conditions the potentiometer “airflow” should be turned slightly over the switch-point.
8. Review the settings: In order to review the settings turn the air flow off, the yellow LED extinguishes, the potential-free switcher operates, activate the air flow, the yellow LED lights up, the potential-free switcher operates again.

The air flow monitor is now adjusted to monitoring function.

Please find the relation between air flow and switching position of the potential-free switcher below:

Flow $\geq$ Threshold value	Signal output switches	yellow LED „airflow“ lights up
Flow $<$ Threshold value	Signal output does not operate	yellow LED „airflow“ does not light up

Please do not hesitate to contact us in case of questions or problems.

Technical development and errors reserved Revision status: 01/2021